

Oversigt over eksisterende teknologier for luftrensning

Lei Fang

International centre for indoor environment and energy
Technical University of Denmark

Air Cleaning

- Particle filtration
- Gas phase pollutants removal
- Germicidal air purification

Gas phase air purification technologies

Oxidation

- Ozone oxidation
- Thermal catalytic oxidation (TCO)
- Photo-catalytic oxidation (PCO)
- Non-thermal plasma oxidation

Sorption

- Adsorption filtration
- Botanic filtration

Ozone oxidation

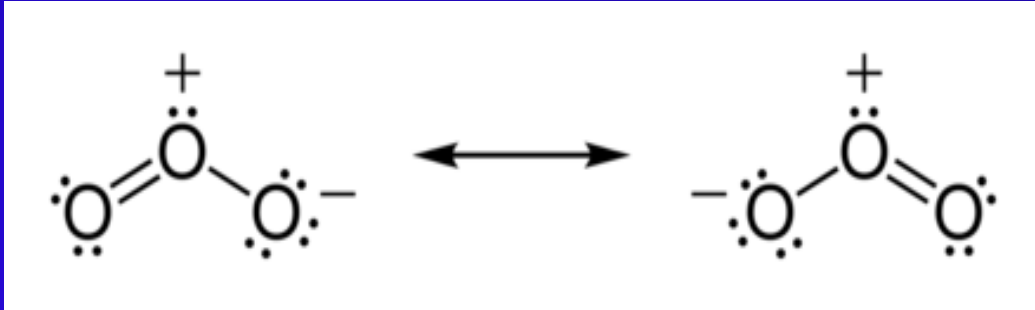

<https://en.wikipedia.org/wiki/Ozone>

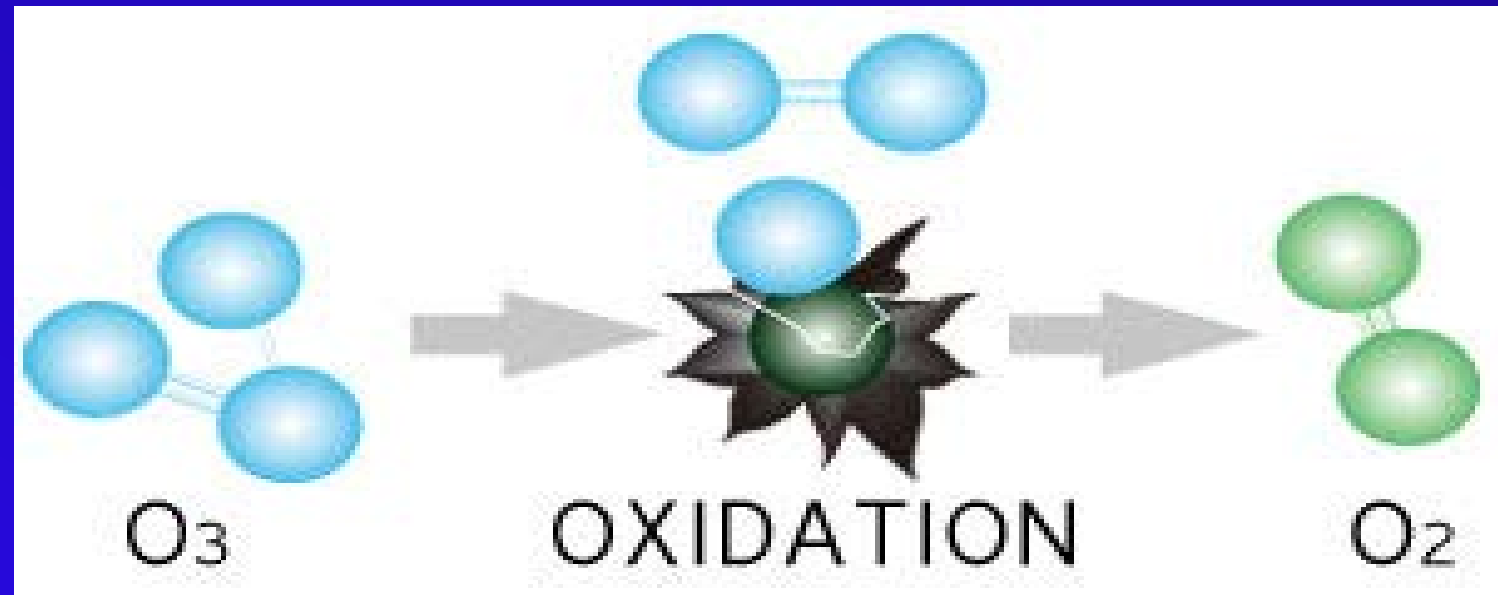

<https://besgroup.wixsite.com/biowell/about-ozone>

Gas-phase advanced oxidation for effective control of air pollution

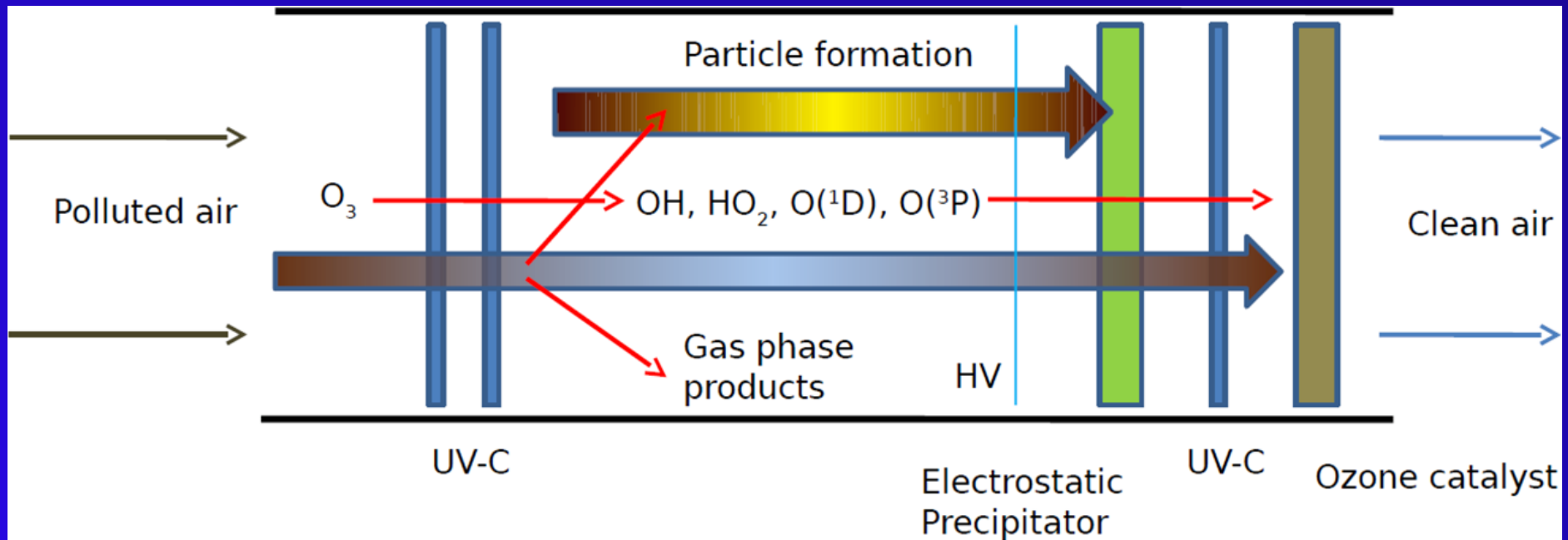

Matthew S. Johnson et al., Environ. Sci. Technol. 2014

Thermal catalytic oxidation (TCO)

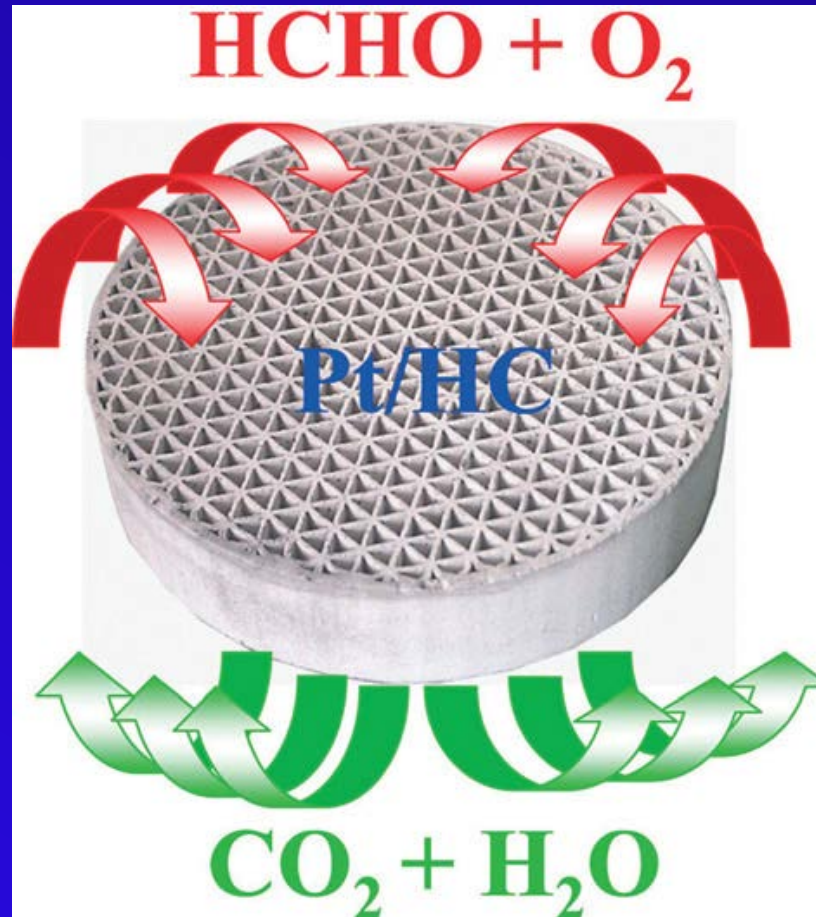

Longhui Nie et al., Catal. Sci. Technol., 2016

Photo-catalytic Oxidation

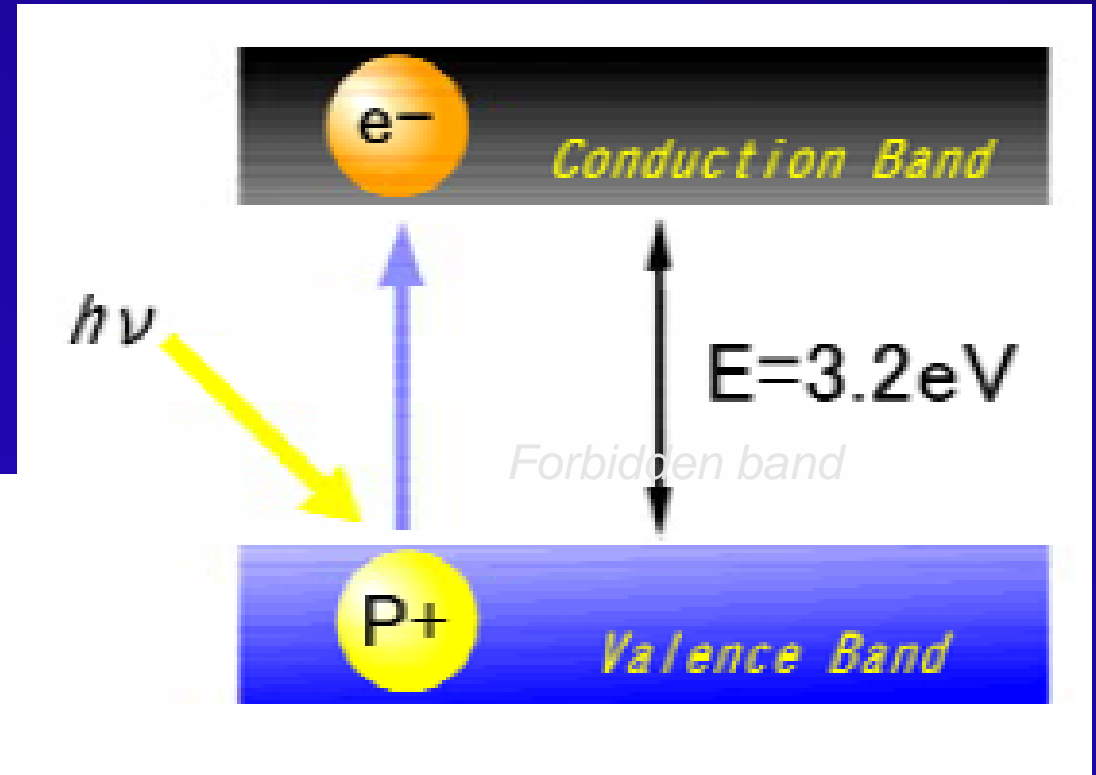
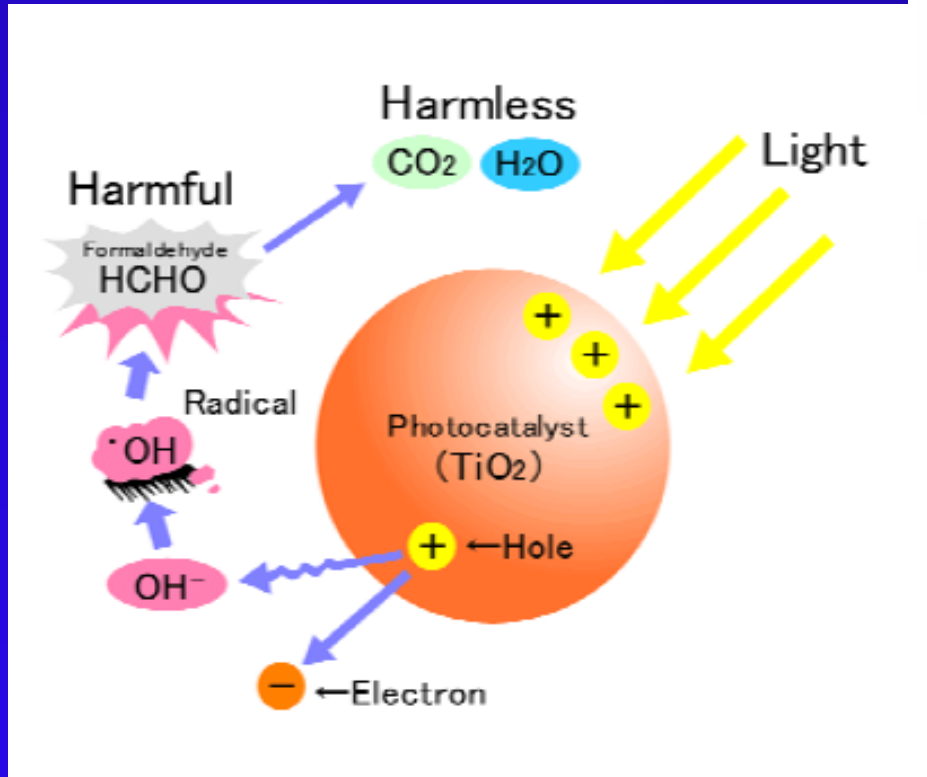

Non thermal plasma oxidation

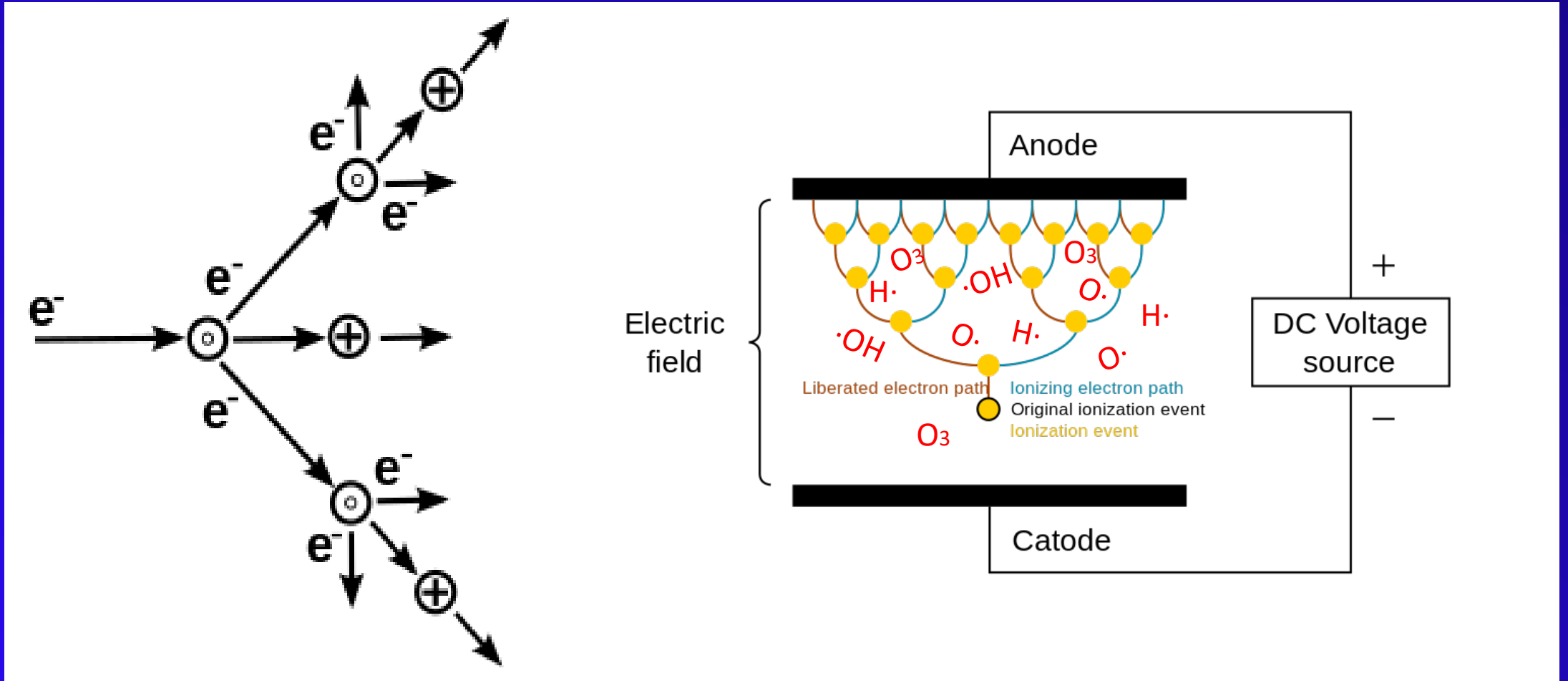

Sorption filtration

Activated carbon

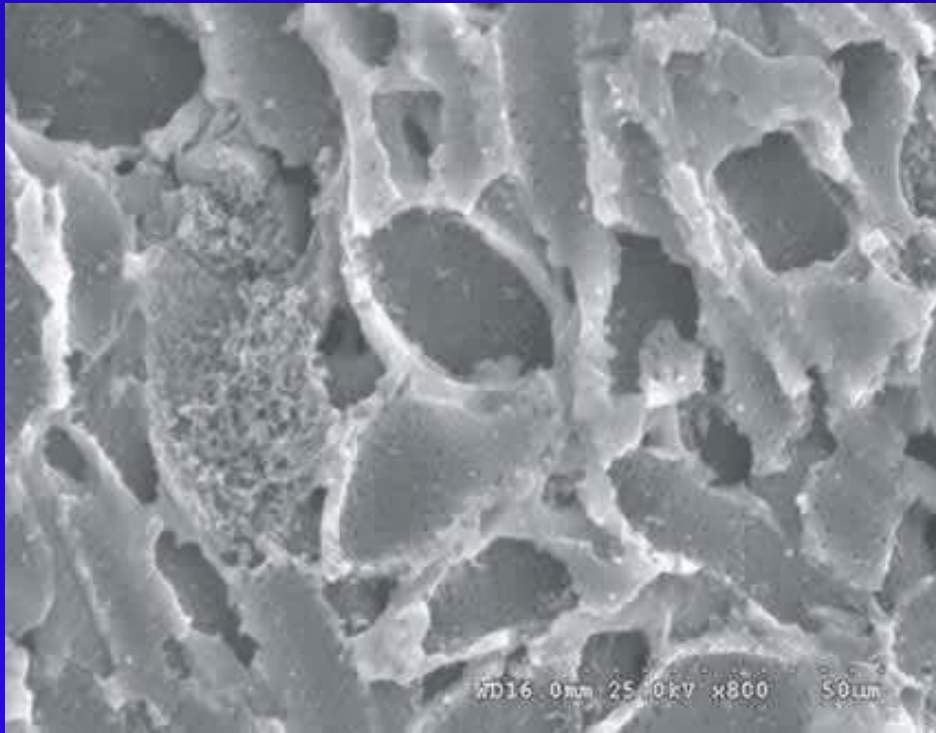

Pore
Size (nm)

Surface
area (m²/g)

<2

100-1000

2-50

10-100

>50

0.5-2

Sorption filtration

Silica gel

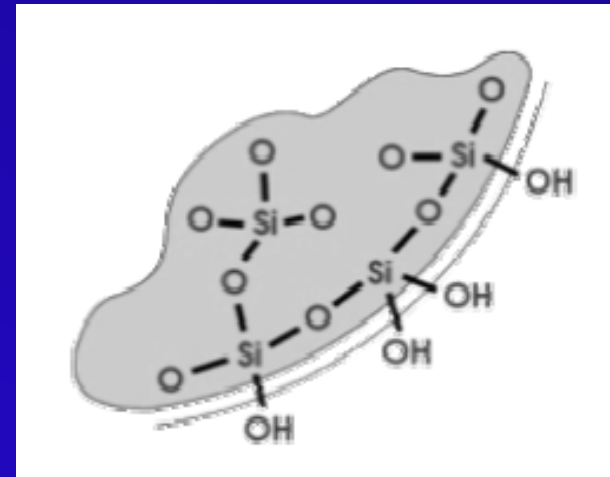
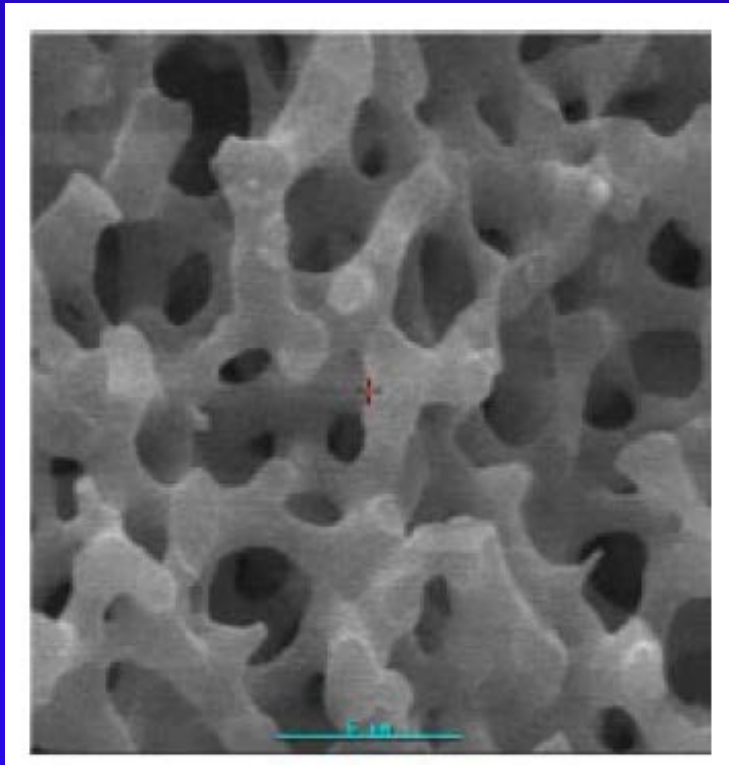

www.gracedavison.com

Pore size (nm)	1-40
Surface area (m ² /g)	800

Regenerative desiccant wheel as air cleaner

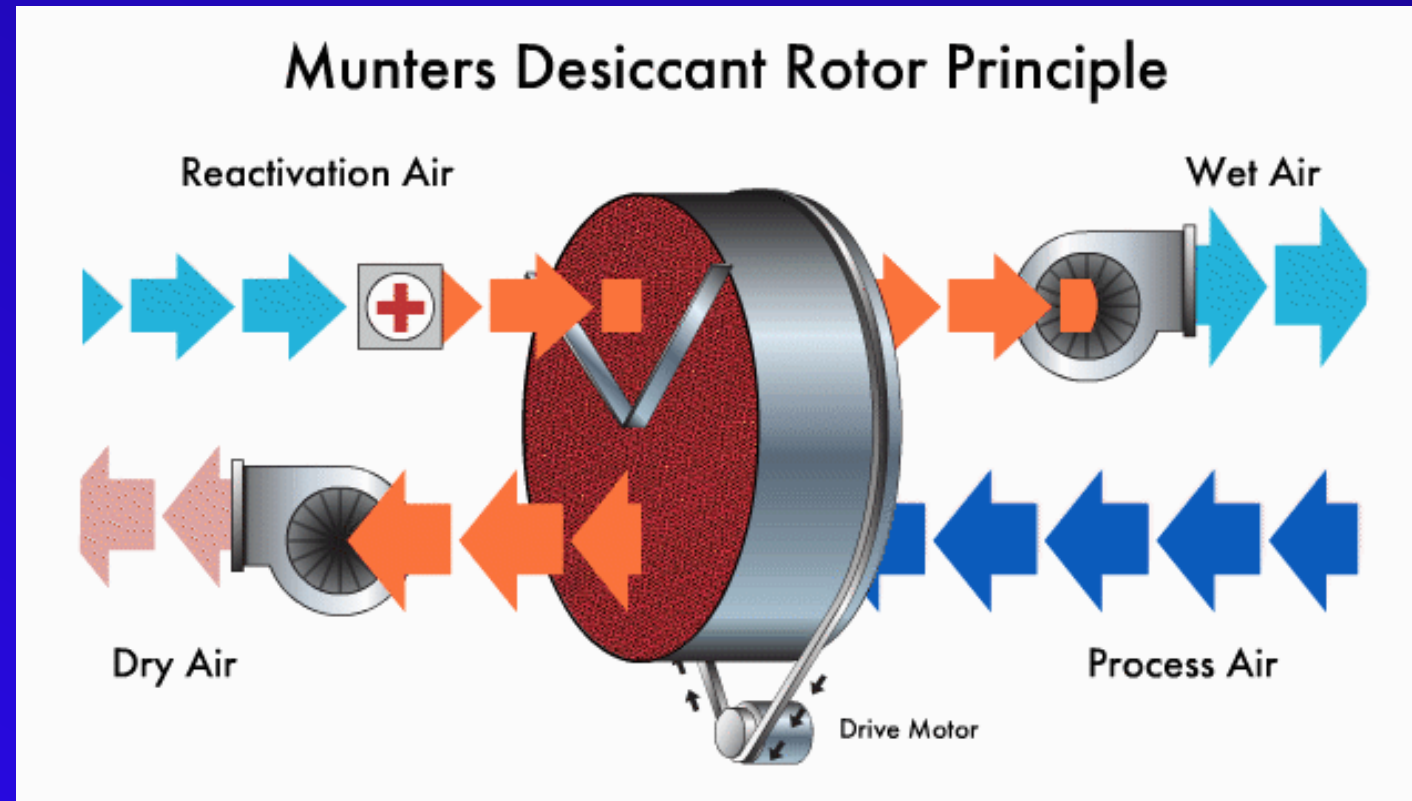

Regenerative desiccant wheel as air cleaner

- Adsorption of gas phase chemicals by desiccant in the process section of the rotor
- Desorption of chemicals from the desiccant in the reactivation section of the rotor

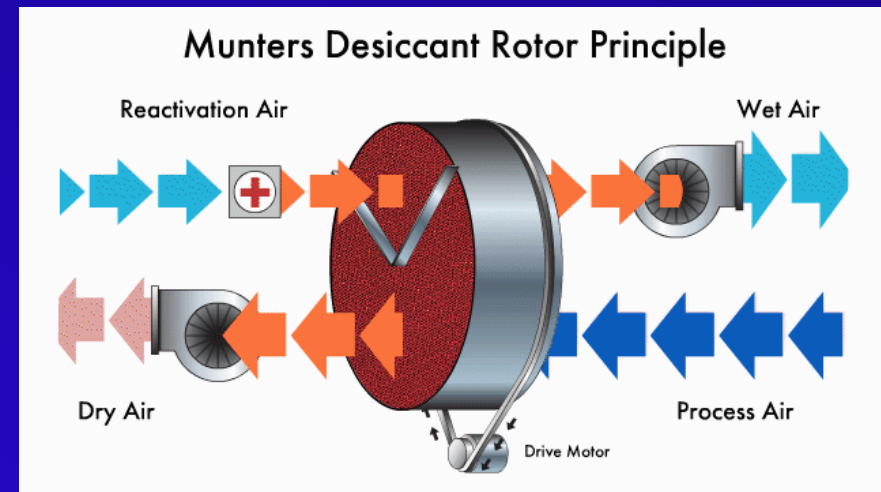

<https://www.munters.com/en/solutions/dehumidification/>

Results when using flooring materials as pollution source

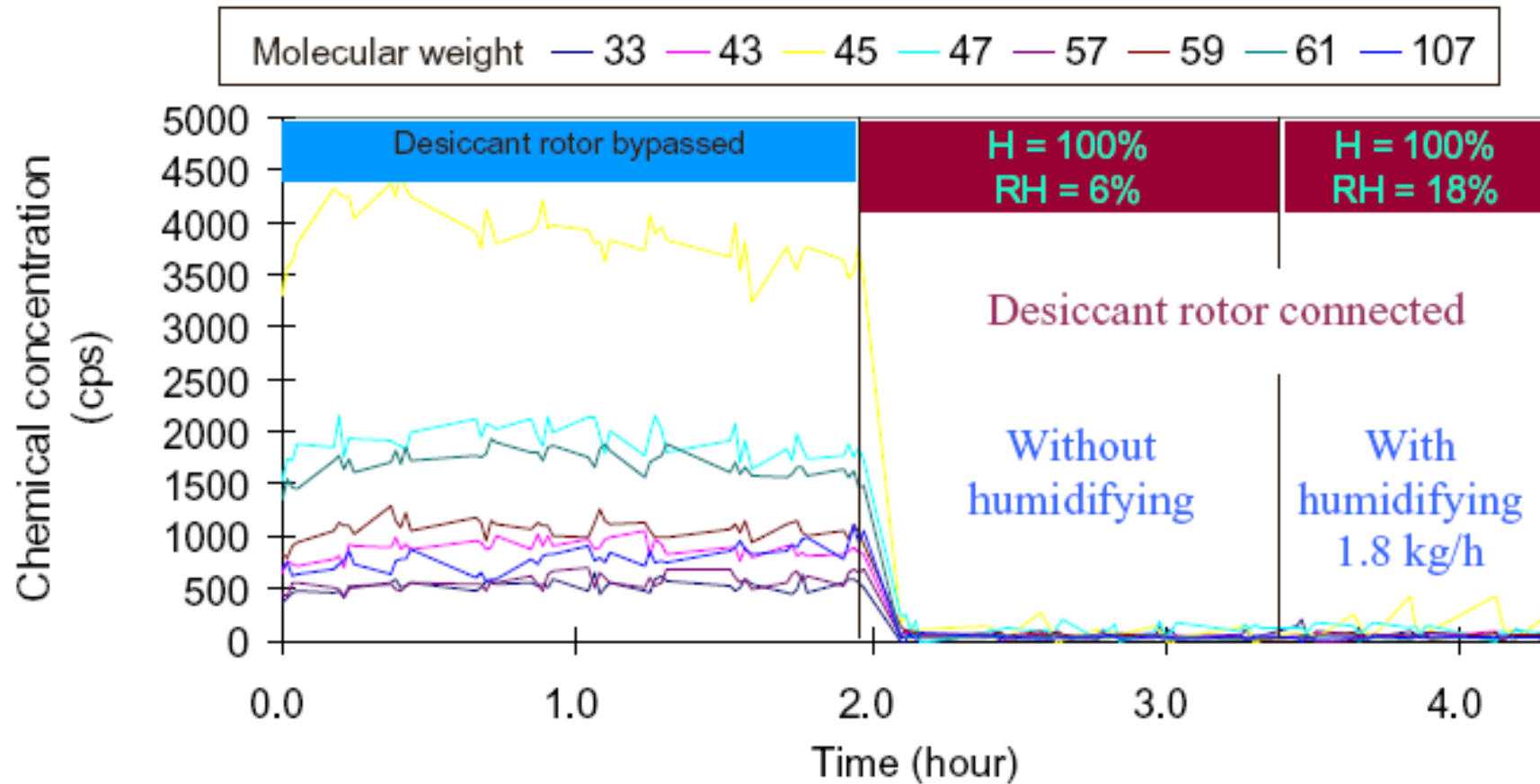

Desiccant wheel and heat pump hybrid air-conditioning system (summer application)

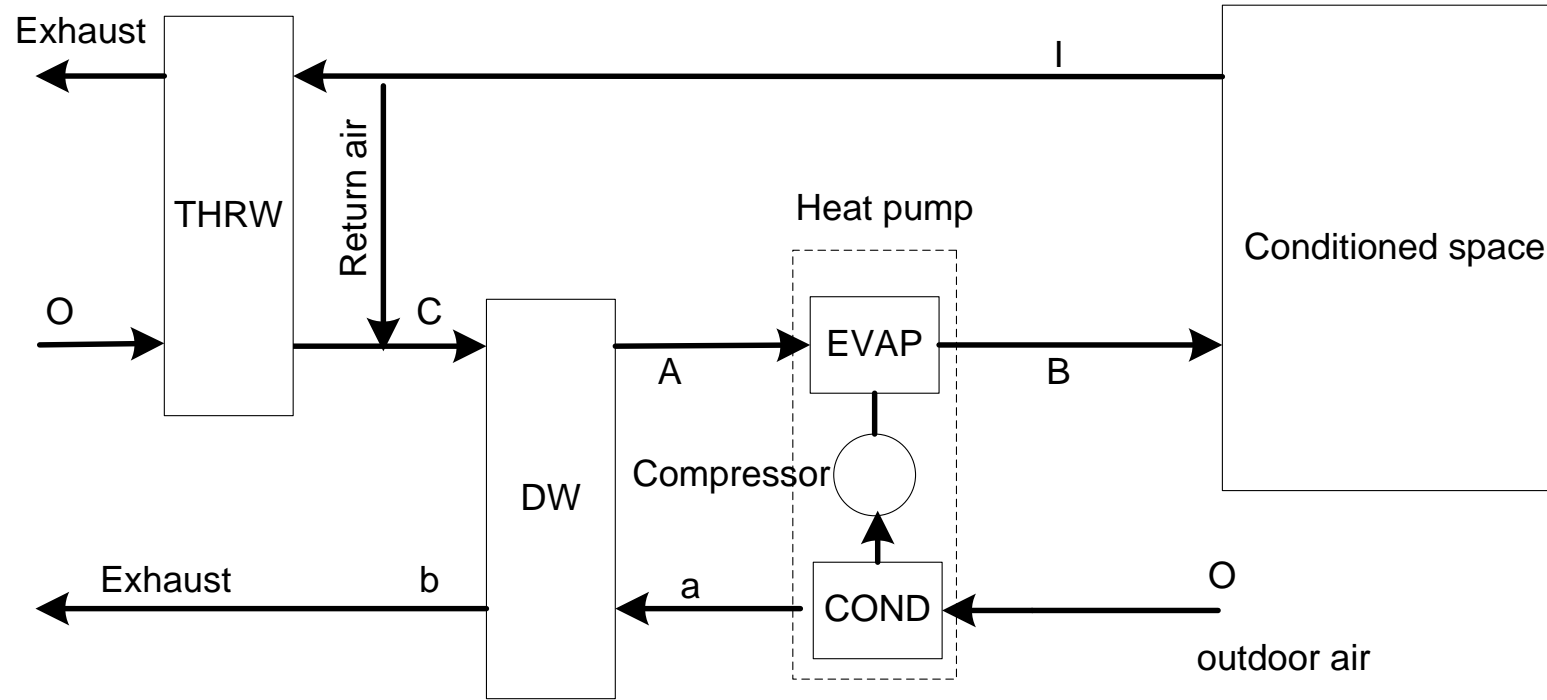

DW: Rotary dehumidifier;
EVAP: Evaporator;

THRE: Total heat recovery equipment
COND: Condenser

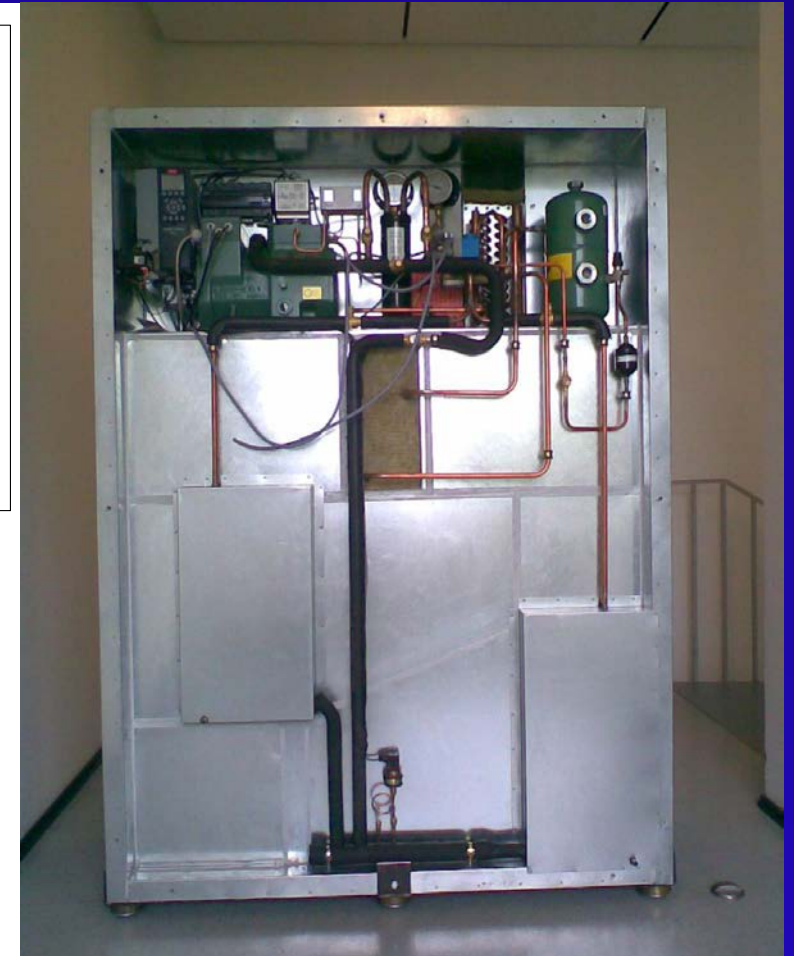

Botanic air cleaning

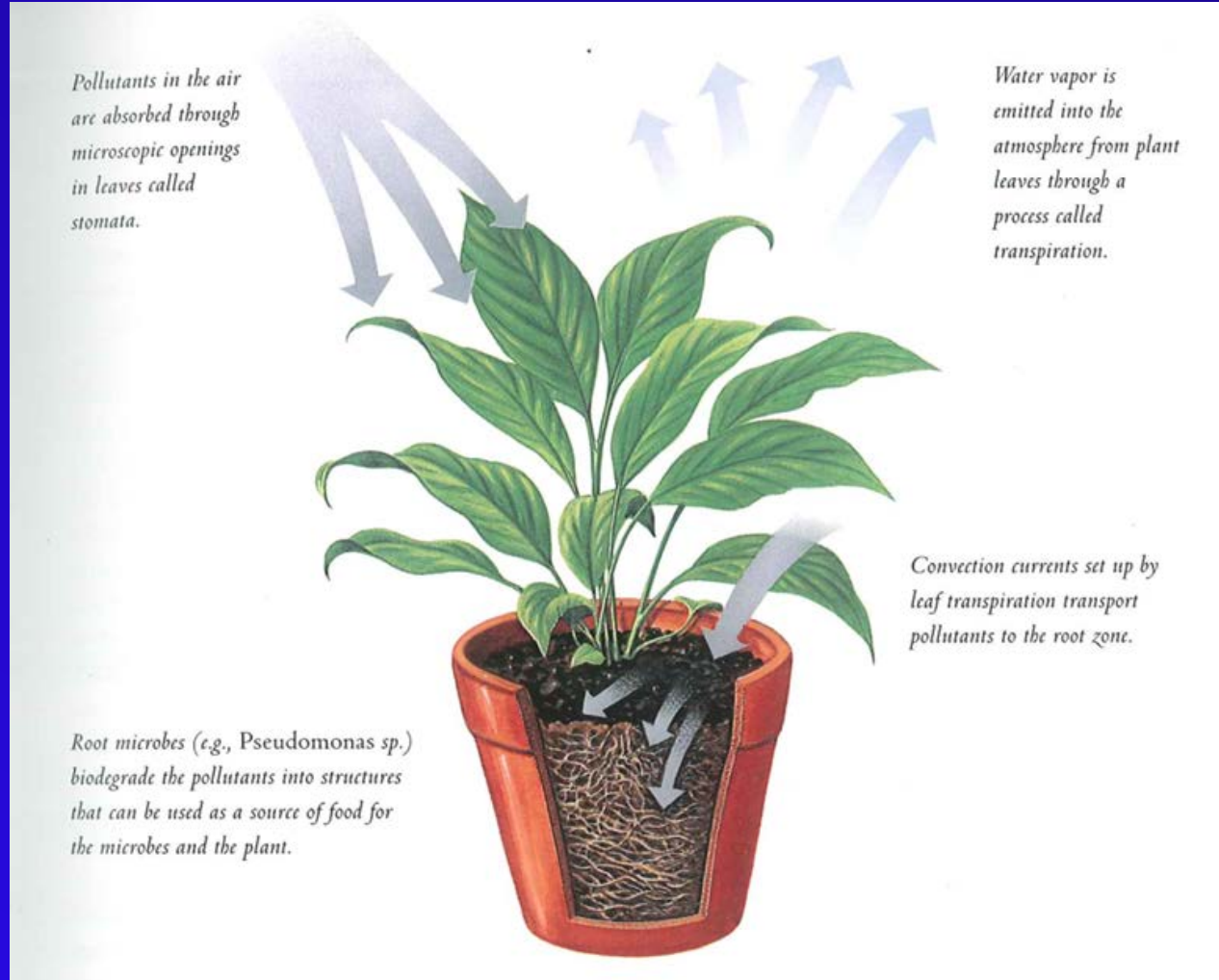

Remarks from literature review

- Most studies were short-term laboratory study. There is a lack of long-term and large scale studies in real space.
- There are very few examples of carefully performed experiments on the associations between air cleaner use and human health.
- There are too limited measured data on the impact of air cleaning on larger commercial systems to demonstrate the tradeoffs between ventilation and air cleaning for pollutant removal.

Thanks!